





,

.

:



...

.

-
-
-
-
-
-

Triple R

Triple R



_____?

_____!

_____.

-
-
-

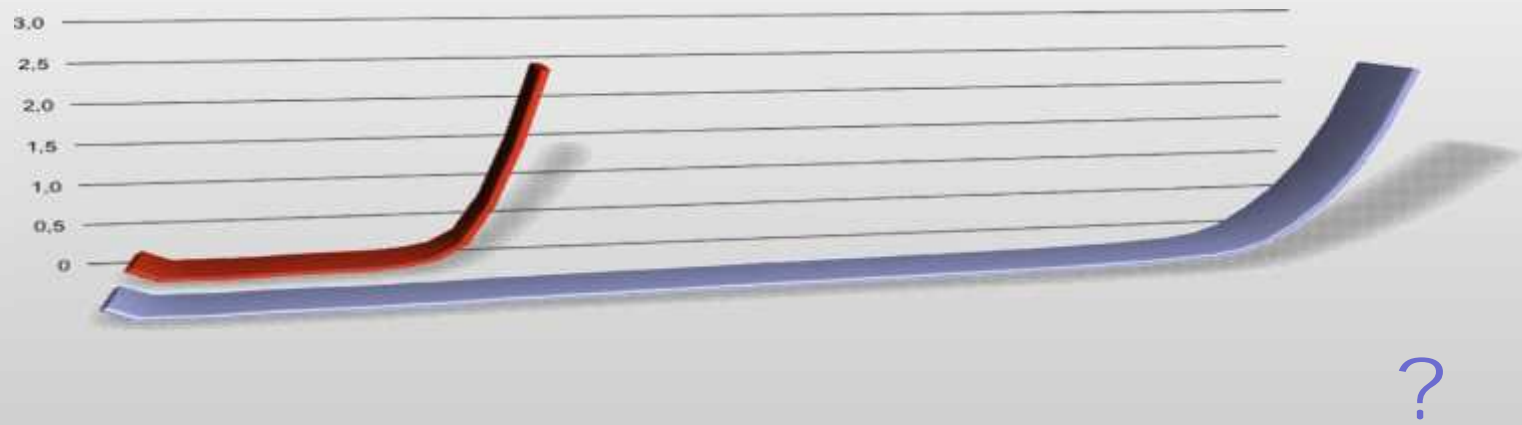

1

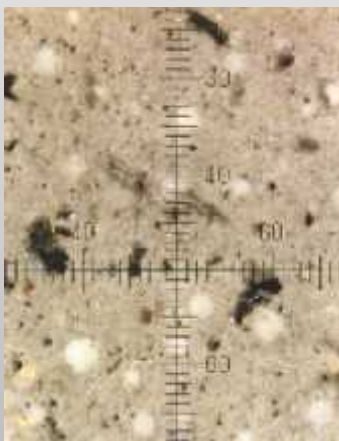

2



3



1.

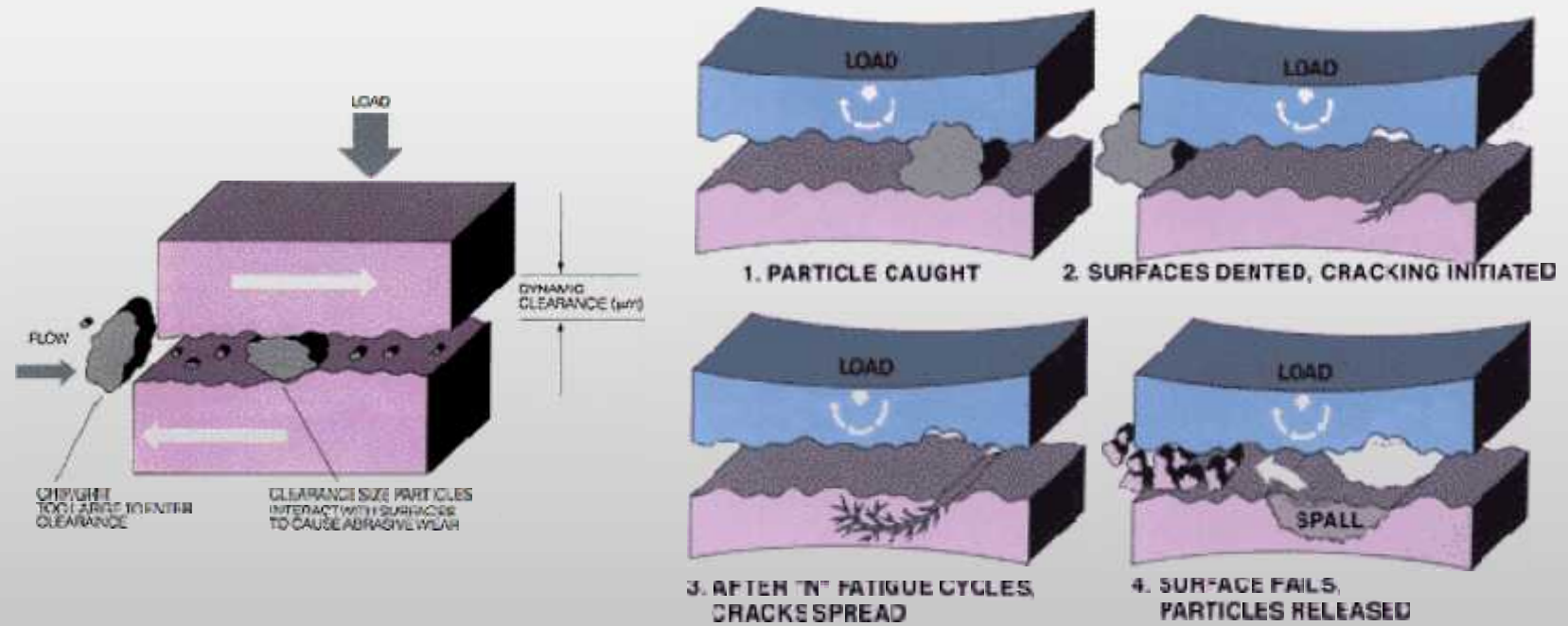

1.

1- NAS 12

3 100

: 2

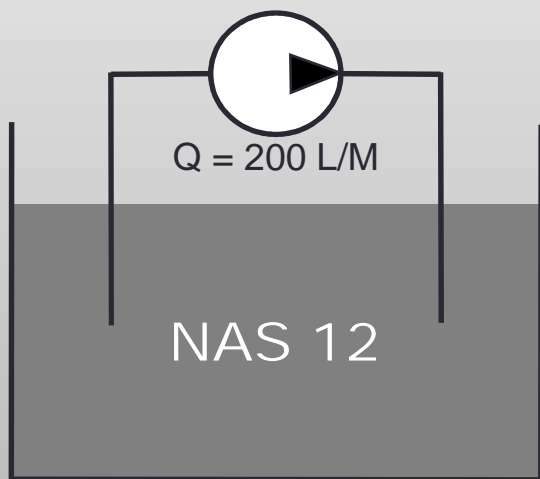

2 - NAS 5

15

: >14

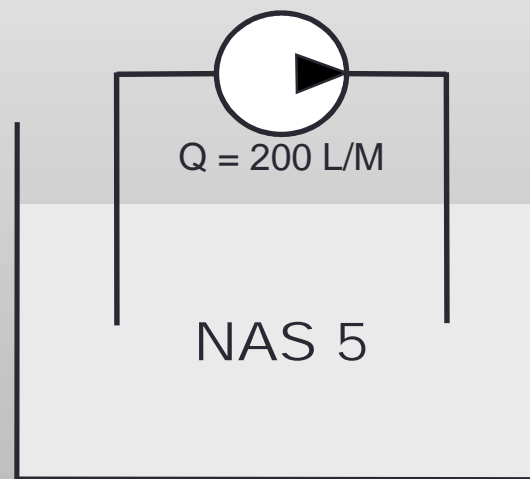

1.

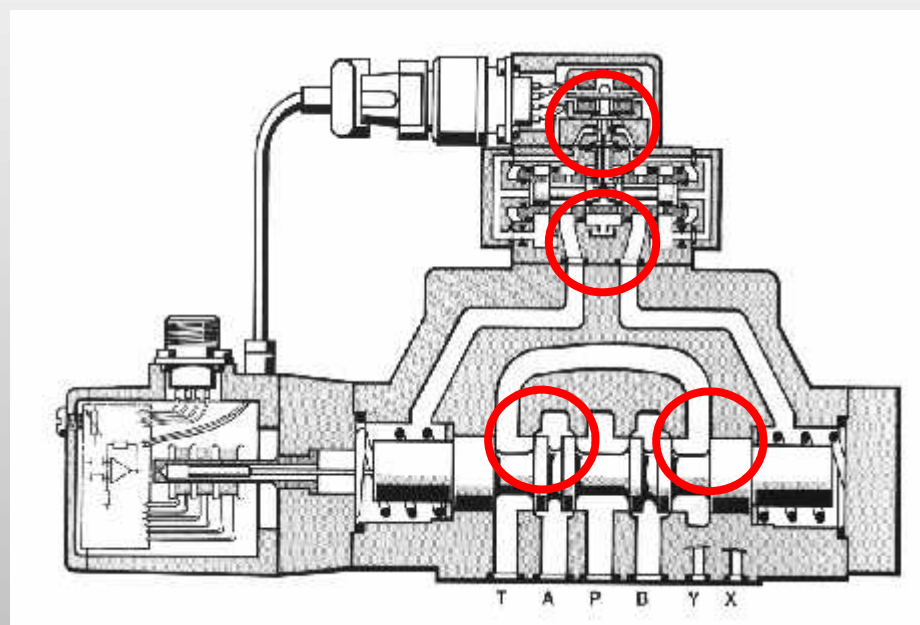

1.

➤ FE = x 48

➤ CU = x 66

*

➤ + 10° C = x 2

2.

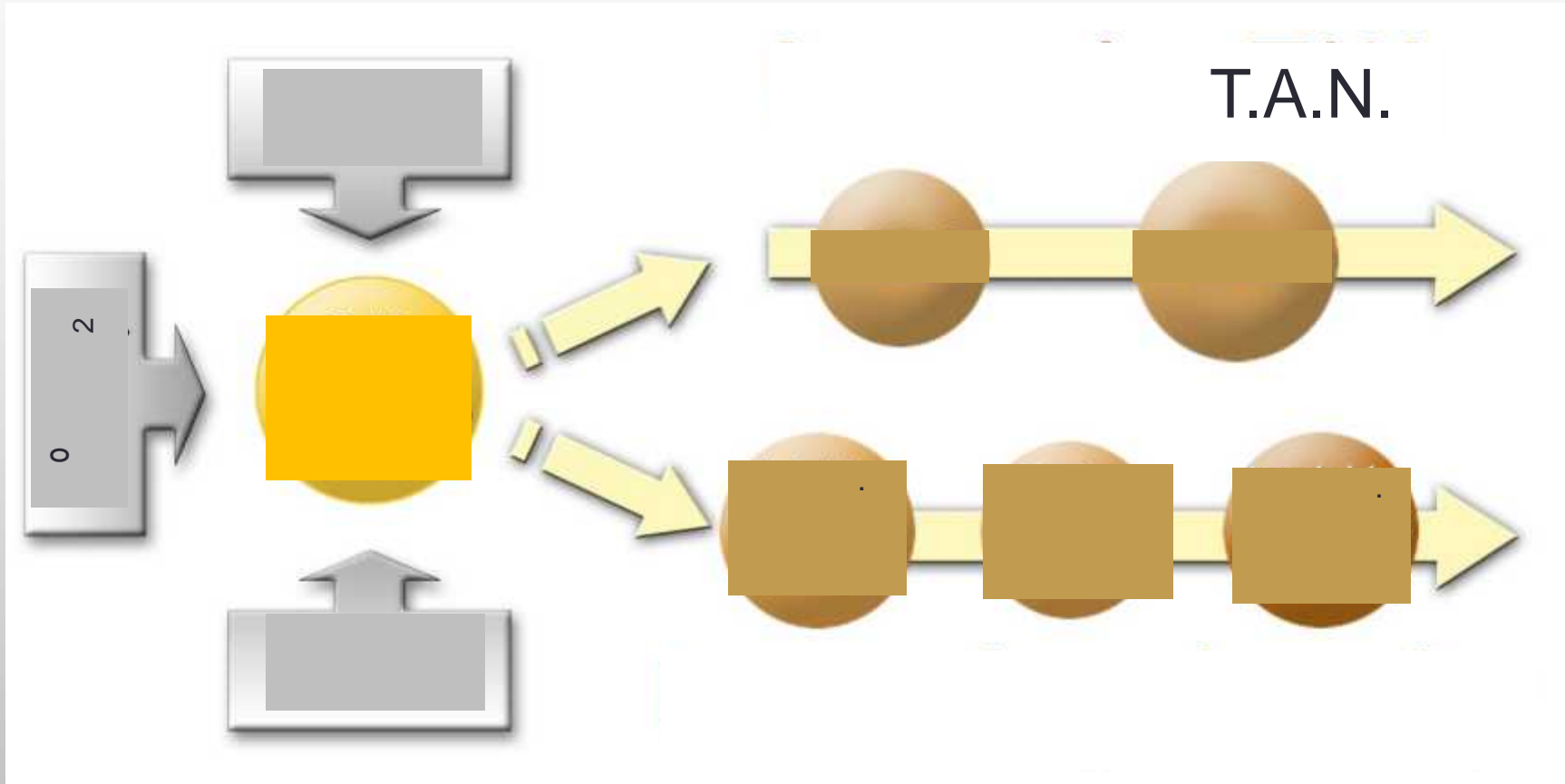

2.



2.

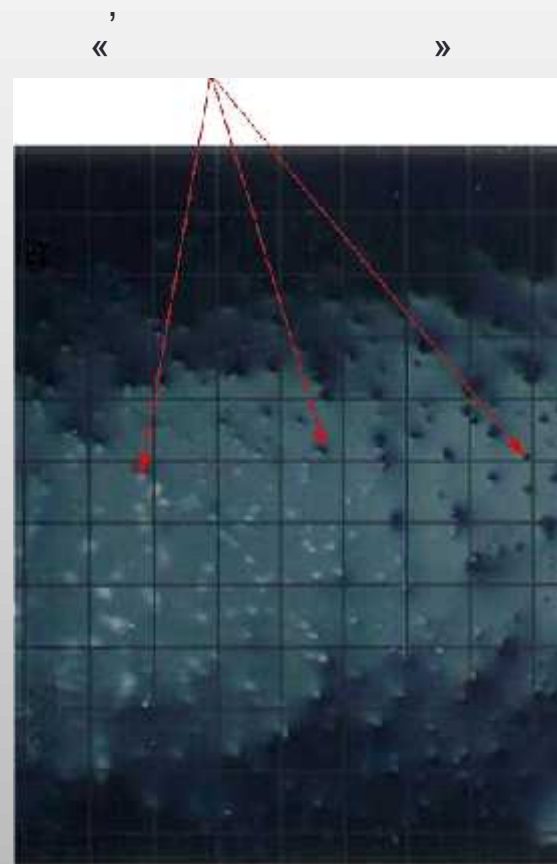
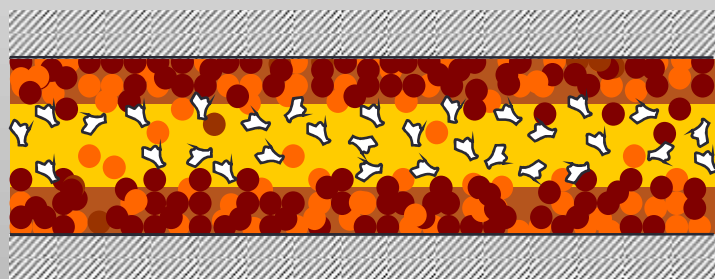
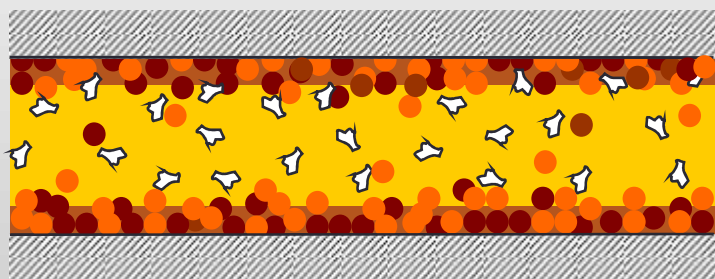
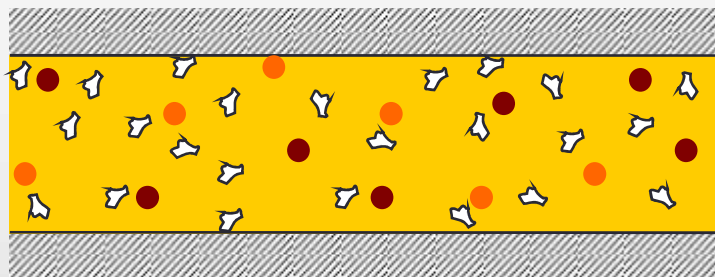

3.

- , 20%
-
-

■ + , - T.A.N. 3500
■ - T.A.N. 400

*T.A.N.

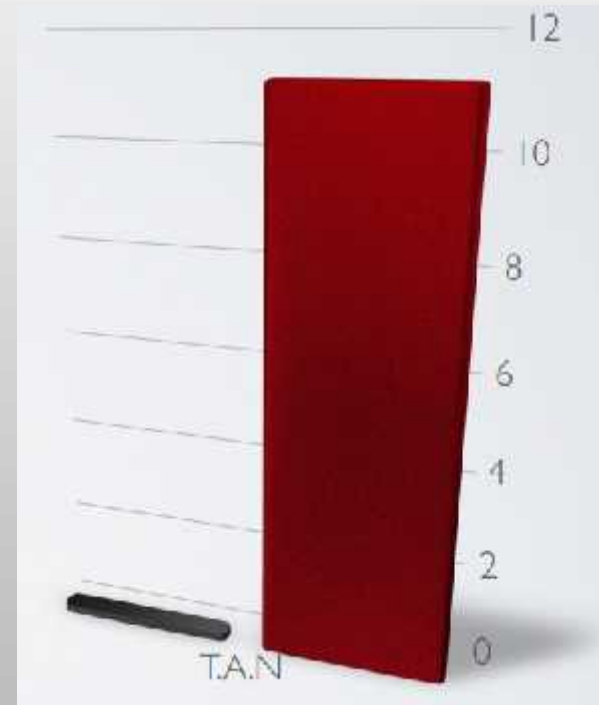

3.

				T.A.N.
1	-	-	+3500	0,17
2	-	+++	+3500	0,90
3	FE	-	+3500	0,65
4	FE	+++	400	8,10
5	CU	-	3000	0,89
6	CU	+++	100	11,20

3.

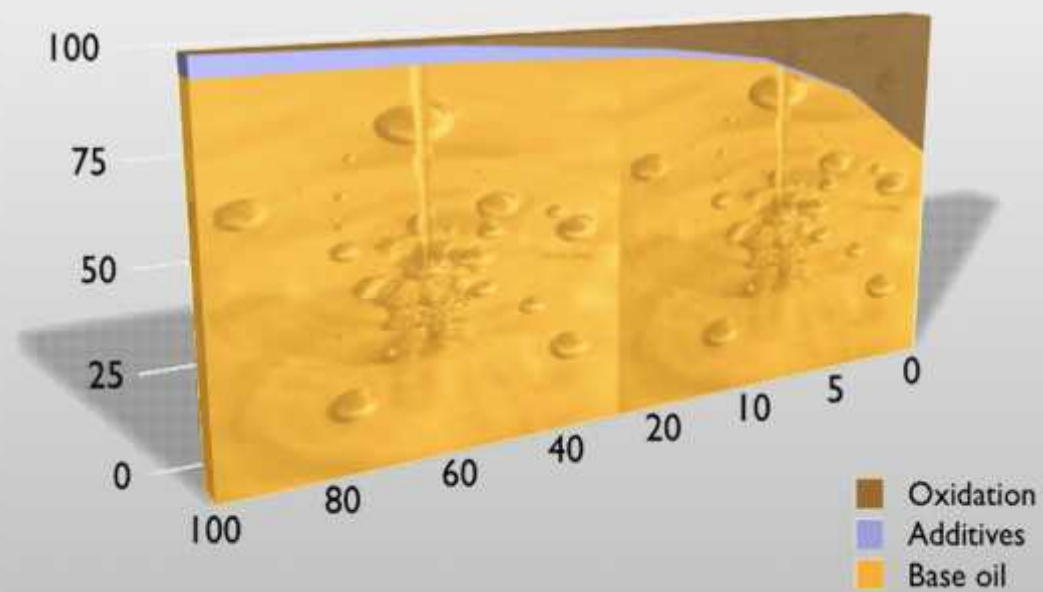



Varnish deposits can cause valves to stick and fail.



Triple R

Triple R –



- 40 Triple R.
-
- « »,
-
-



Triple R?

R:

Reduce

()

Reuse

()

Recycle

()



Triple R?



!

Mr. Russo,
C . 1965 .

Ford Motor

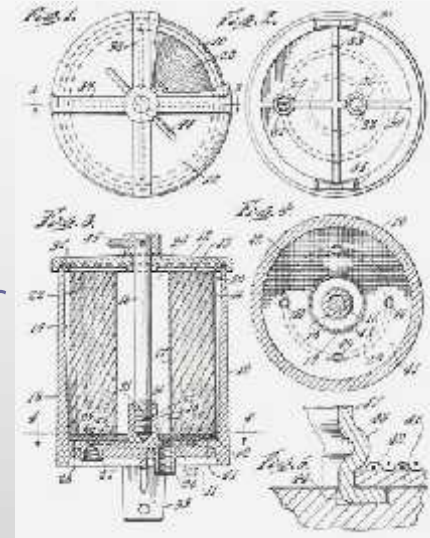

100.000

Co. Ltd.,

1967 .

Triple R

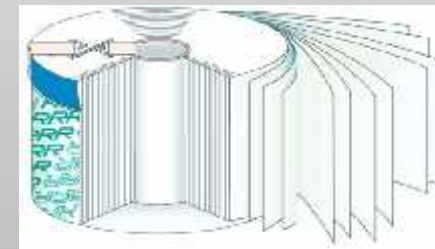

-
-
-

100%

-ratio μ -rating !



M-100

> 400



E-100

₃ > 75



X-100

₅ > 75



, Triple R

114



!

3-

1

2

5

3

1

:

:

:

:

-
-
-
-



Triple R

-
-
-
-

114

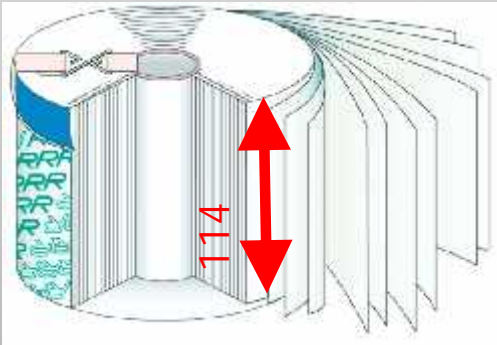

: Triple R

Triple R

C

Triple R

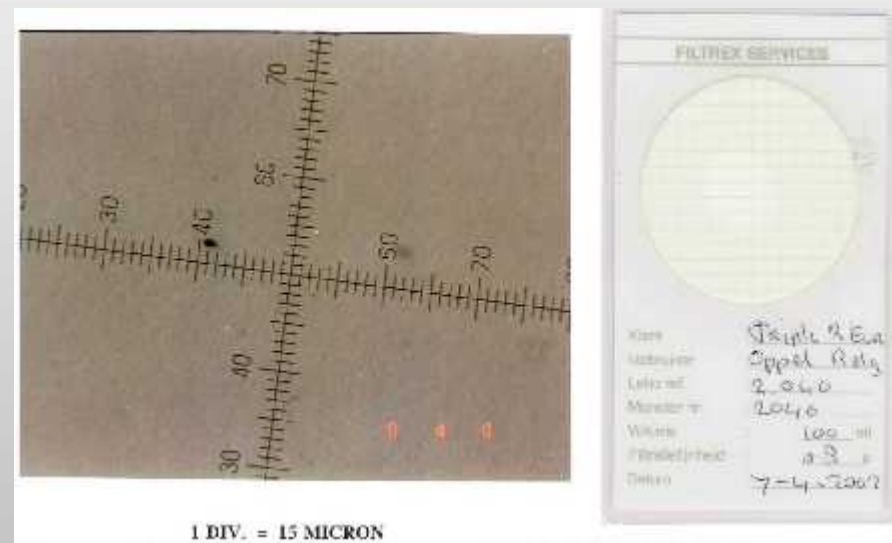
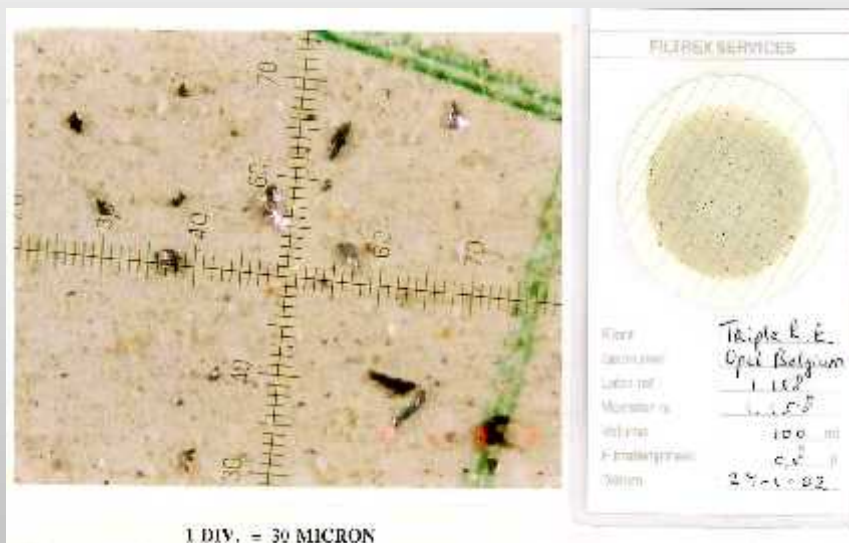

Triple R

Triple R

1. 99% (5 NAS).
2. 100 ppm .
3. .



Triple R?

- -
 -
 -
 -
 -
- 10 35000
- "), (« 2 – 4

Triple R?

:

■ , ,

■ .

■ (, , .)

■ .

■ ,

■ .

■ 2 – 4

-
-
-
-
-

off-line





TR-



BU-



SE-

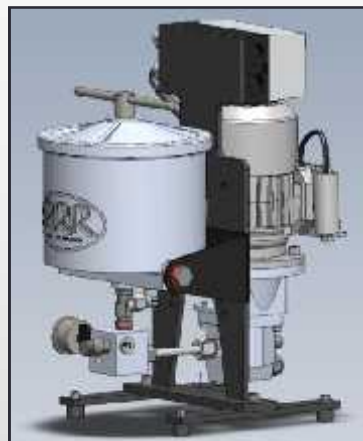

OSCA-



SS-





■ Repair time
■ Failures

TOYOTA –

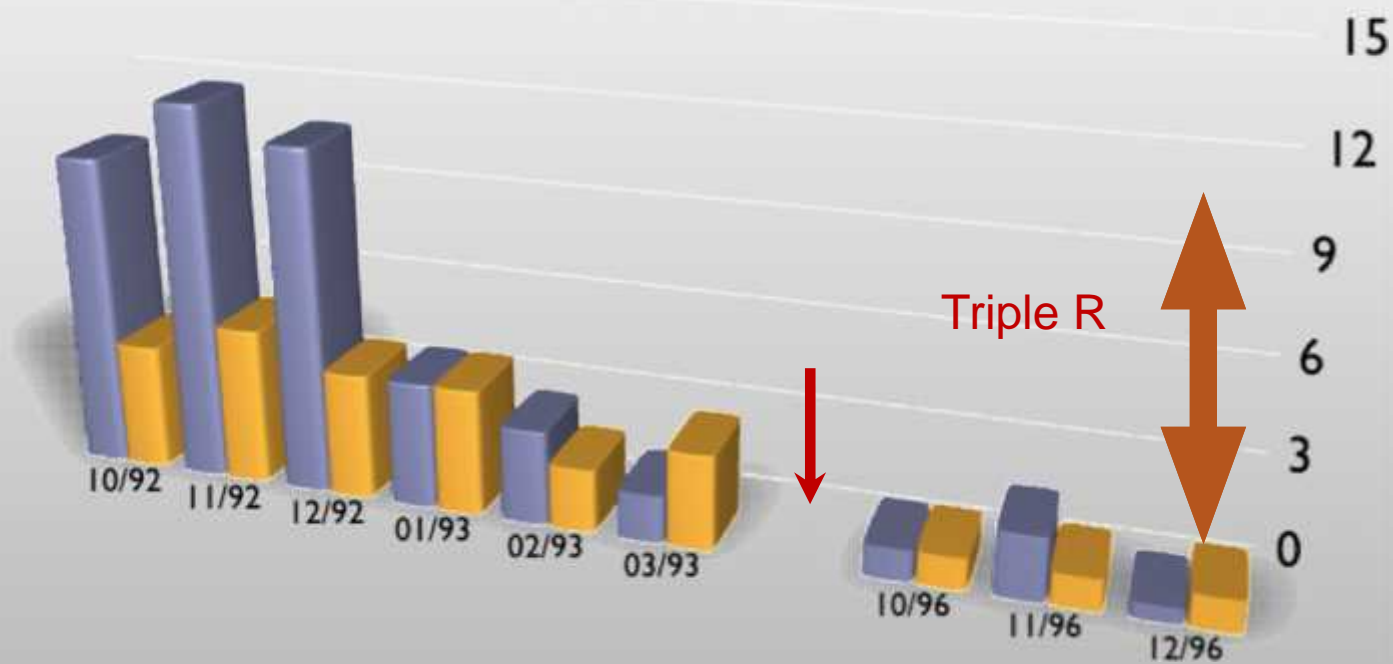

SAAB –

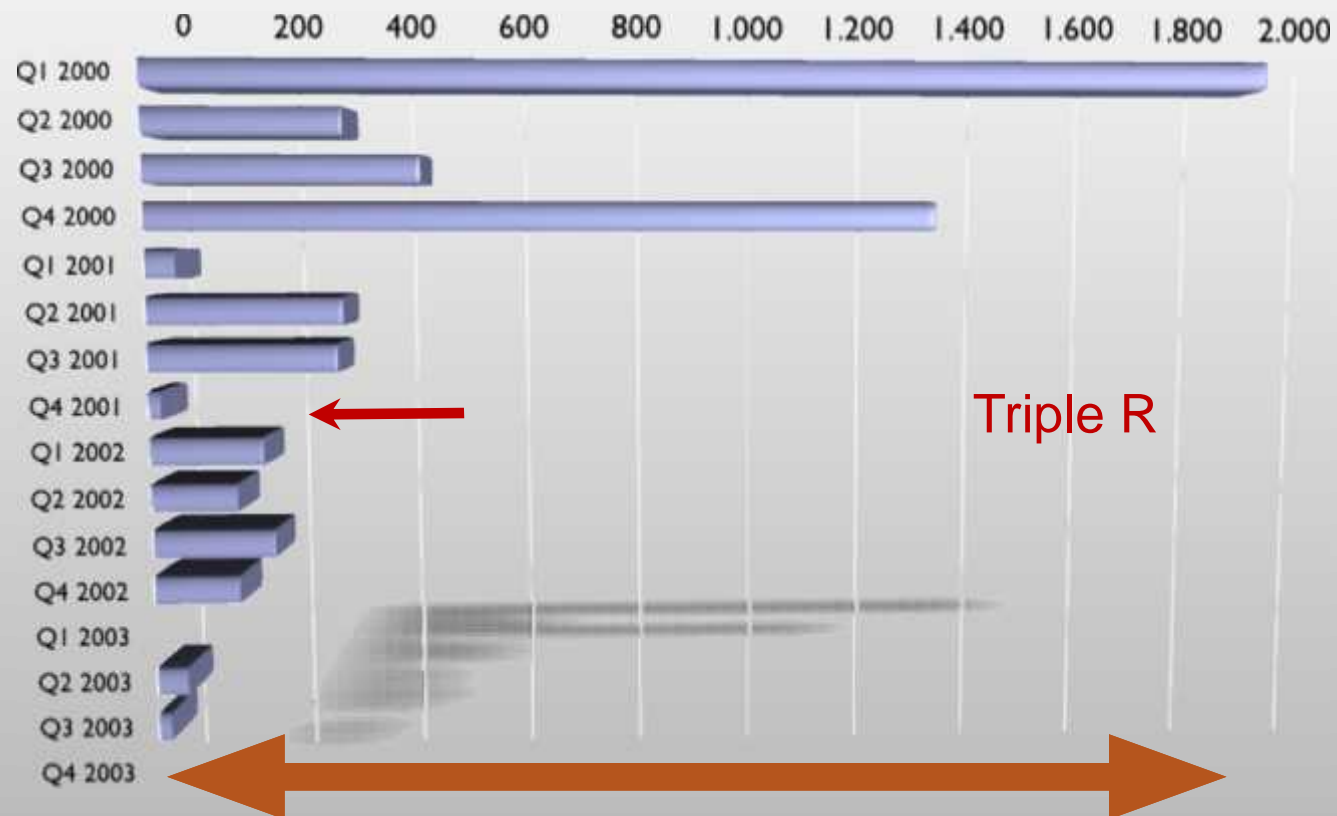

Triple R

C1

NISSAN –

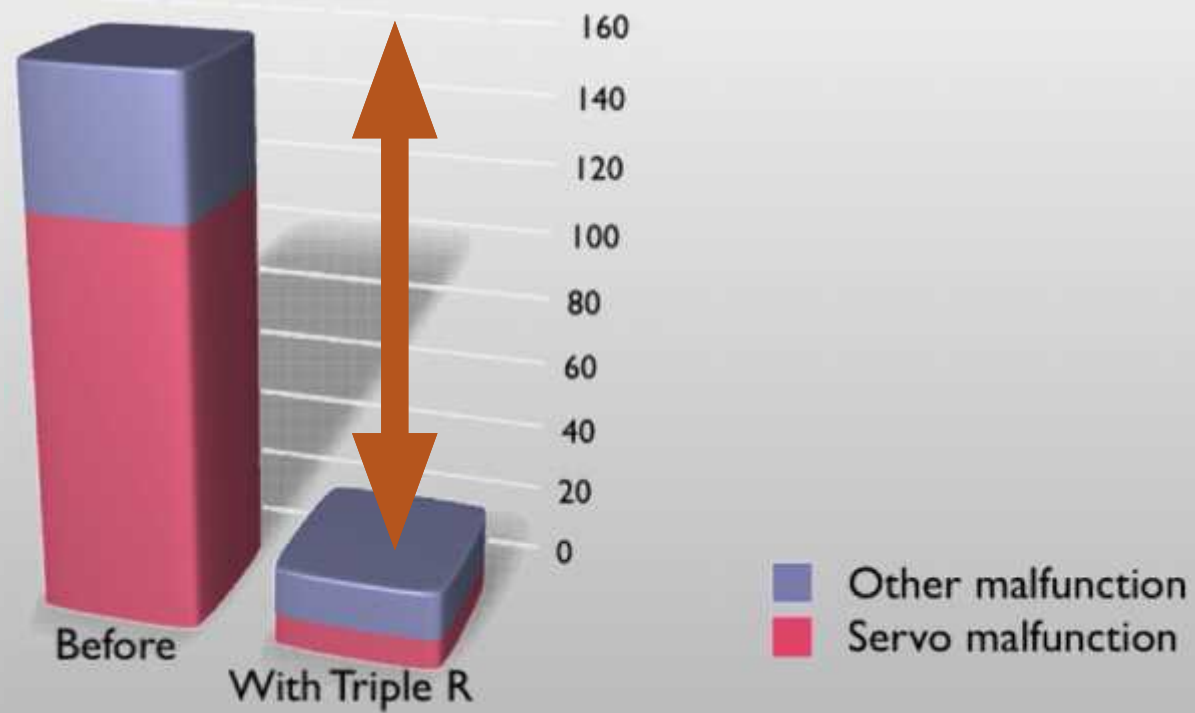

Triple Review

Review for: **Costing and maintenance - Issue 2 - 2015**



The **FINNAIR** story



Mr. Jarmo is Manager, **Costing, Equipment & Inventory** at Finnair (IATA: FIN).

Mr. Jarmo has worked for the company for 25 years and is responsible for the maintenance department.

Every morning he checks the status of the fleet and the maintenance work.

Applications

There are a large number of equipment types used in the maintenance department.

These machines are used for the maintenance of aircraft.

The machines are used for the maintenance of aircraft.

These machines are used for the maintenance of aircraft.

These machines are used for the maintenance of aircraft.

These machines are used for the maintenance of aircraft.

Triple Review

Review for: **Costing and maintenance - Issue 2 - 2015**



The **VAN WERVEN** story

Van Werven is a leading manufacturer of construction equipment.

The company has a long history of innovation and quality.

Van Werven is a leading manufacturer of construction equipment.

Applications

Van Werven machines are used in various construction sites.

The machines are used for digging, grading, and lifting.

Van Werven machines are used in various construction sites.

Triple Review

Review for: **Costing and maintenance - Issue 2 - 2015**



The **HERRMANS** story



Mr. Conrad is the manager of the maintenance department at Herrmans.

He has been working for the company for many years.

Applications

Herrmans machines are used in various industrial settings.

The machines are used for material handling and processing.

Herrmans machines are used in various industrial settings.

:

Flextronics, Lego, Tyrolia Head, Plastic Omnium,
Möllertech, Behr, Rehau, Playmobil, Curver, Delsey,
Tupperware, Sony, Nokia, Trelleborg, Ericcson,
BIC, Quadrant CMS, GE, Dymo, Texas Instruments, ...

OEM- :

Nissei, Sumitomo, Toyo, Ube, Meiki, Mitsubishi,
Toshiba, Sanwa Seiki, Haitian Machinery, Huarong,
Chuan li Fa, Billion, Maicopress, Deu, ...





Agfa Gevaert – Esselte – Bekaert – Tetra Pak – Neste – Nitto
ALZ – Terumo – Metso Paper – VR – Axima – Texas Instruments
Volvo – Opel – Toyota – Nissan – Chrysler – Komatsu – Kato
Caterpillar – Hitachi – Normet – Finnair – Ericsson – Rexam
Amada – Playmobil – Curver – Ford - Vredestein – Carman
Tupperware – Engel – Mannesman Demag – ABB – Sony – URS
Tyco – NS – Coca-Cola – Peugeot – Corus – Hoogovens – Spa
NEC – Denso – Citizen – Toshiba – Bridgestone – Panasonic
Kubota – Sumitomo – Mitsubishi – Nippon Steel – Honda – JR
Saab – Finnforest – Flextronics – Framatome – Gremo – YIT
Kockums – Junttan – Kährs – Banverket – Stora Enso – Wärtsilä
Black&Decker – GM – Yale – Boeing – Hyster – Mercedes-Benz

!

-
-
-
-
-

Triple R

Triple R

